

# Bipolar Transistor

(-)100 V, (-)2 A, Low  $V_{CE(sat)}$ , (PNP)NPN  
Single TP/TP-FA

## 2SA1593 / 2SC4135

### Features

- Adoption of FBET, MBIT Process
- Fast Switching Speed
- Small and Slim Package Permitting 2SA1593 / 2SC4135 – Applied Sets to be Made More Compact
- High Breakdown Voltage and Large Current Capacity

### Applications

- Power Supplies, Relay Drivers, Lamp Drivers

**SPECIFICATIONS** ( ): 2SA1593

**ABSOLUTE MAXIMUM RATINGS** at  $T_a = 25^\circ\text{C}$

Parameter	Symbol	Conditions	Ratings	Unit
Collector-to-Base Voltage	$V_{CBO}$	-	(-)120	V
Collector-to-Emitter Voltage	$V_{CEO}$	-	(-)100	V
Emitter-to-Base Voltage	$V_{EBO}$	-	(-)6.0	V
Collector Current	$I_C$	-	(-)2.0	A
Collector Current (Pulse)	$I_{CP}$	-	(-)3.0	A
Collector Dissipation	$P_C$	-	1.0	W
		$T_C = 25^\circ\text{C}$	15	W
Junction Temperature	$T_j$	-	150	$^\circ\text{C}$
Storage Temperature	$T_{stg}$	-	- 55 to +150	$^\circ\text{C}$

Stresses exceeding those listed in the Maximum Ratings table may damage the device. If any of these limits are exceeded, device functionality should not be assumed, damage may occur and reliability may be affected.

### ELECTRICAL CONNECTION

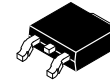
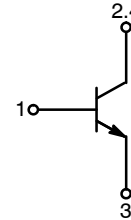

DPAK / TP-FA  
CASE 369AH

### MARKING DIAGRAM

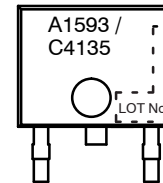

### ORDERING INFORMATION

Device	Package	Shipping†
2SA1593S-TL-E	DPAK / TP-FA	700 / Tape & Reel
2SC4135T-TL-E	DPAK / TP-FA	700 / Tape & Reel

†For information on tape and reel specifications, including part orientation and tape sizes, please refer to our Tape and Reel Packaging Specifications Brochure, [BRD8011/D](#).

# 2SA1593 / 2SC4135

## ELECTRICAL CHARACTERISTICS (at Ta = 25°C)

Parameter	Symbol	Conditions	Ratings			Unit
			Min	Typ	Max	
Collector Cutoff Current	$I_{CBO}$	$V_{CB} = (-)100\text{ V}, I_E = 0\text{ A}$	-	-	(-) $100$	nA
Emitter Cutoff Current	$I_{EBO}$	$V_{EB} = (-)4\text{ V}, I_C = 0\text{ A}$	-	-	(-) $100$	nA
DC Current Gain	$h_{FE}$	$V_{CE} = (-)5\text{ V}, I_C = (-)100\text{ mA}$	100*	-	400*	
Gain-Bandwidth Product	$f_T$	$V_{CE} = (-)10\text{ V}, I_C = (-)100\text{ mA}$	-	120	-	MHz
Output Capacitance	$C_{ob}$	$V_{CB} = (-)10\text{ V}, f = 1\text{ MHz}$	-	(25)16	-	pF
Collector-to-Emitter Saturation Voltage	$V_{CE(sat)}$	$I_C = (-)1\text{ A}, I_B = (-)100\text{ mA}$	-	(-0.22)0.13	(-0.6)0.4	mV
Base-to-Emitter Saturation Voltage	$V_{BE(sat)}$	$I_C = (-)1\text{ A}, I_B = (-)100\text{ mA}$	-	(-)0.85	(-)1.2	V
Collector-to-Base Breakdown Voltage	$V_{(BR)CBO}$	$I_C = (-)10\text{ }\mu\text{A}, I_E = 0\text{ A}$	(-)120	-	-	V
Collector-to-Emitter Breakdown Voltage	$V_{(BR)CEO}$	$I_C = 1\text{ mA}, R_{BE} = \infty$	(-)100	-	-	V
Emitter-to-Base Breakdown Voltage	$V_{(BR)EBO}$	$I_E = 10\text{ }\mu\text{A}, I_C = 0\text{ A}$	(-)6	-	-	V
Turn-On Time	$t_{on}$	See specified Test Circuit	-	(80)80	-	ns
Storage Time	$t_{stg}$		-	(750)1000	-	ns
Fall Time	$t_f$		-	(40)50	-	ns

Product parametric performance is indicated in the Electrical Characteristics for the listed test conditions, unless otherwise noted. Product performance may not be indicated by the Electrical Characteristics if operated under different conditions.

\* The 2SA1593/ 2SC4135 are classified by 100 mA  $h_{FE}$  as follows :

Rank	R	S	T
$h_{FE}$	100 to 200	140 to 280	200 to 400

### Switching Time Test Circuit

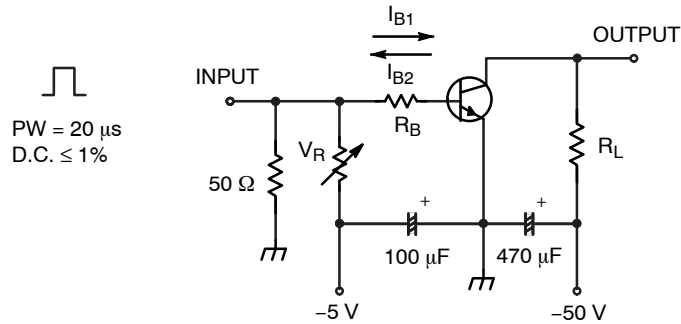

$$I_C = 10I_{B1} = -10I_{B2} = 0.7\text{ A}$$

(For PNP, the polarity is reversed)

Figure 1. Test Circuit

TYPICAL CHARACTERISTICS

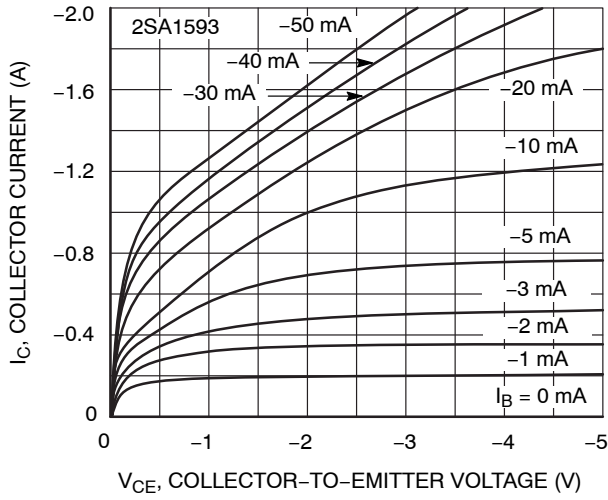

Figure 2.  $I_C - V_{CE}$

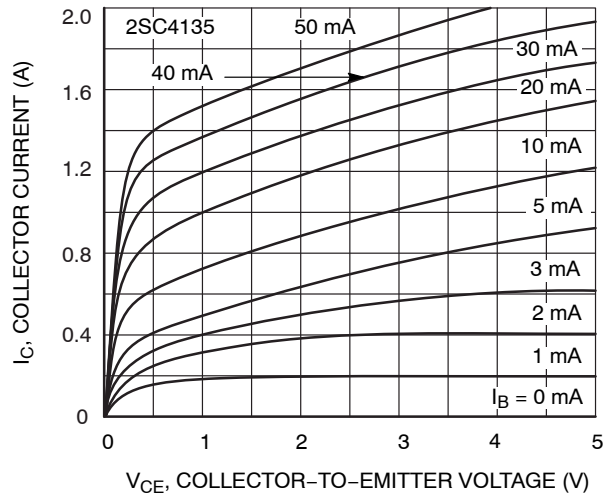

Figure 3.  $I_C - V_{CE}$

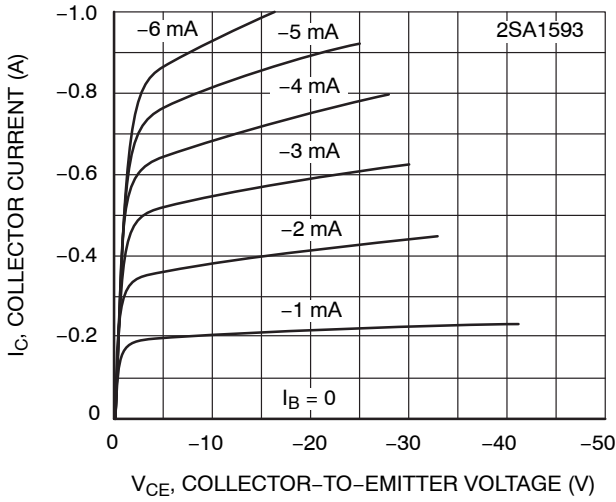

Figure 4.  $I_C - V_{CE}$

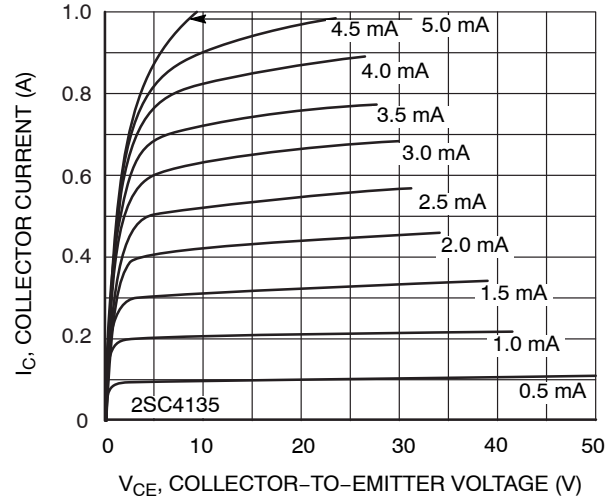

Figure 5.  $I_C - V_{CE}$

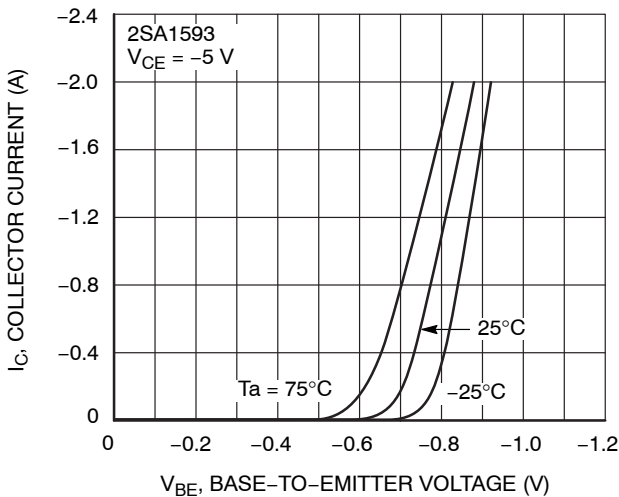

Figure 6.  $I_C - V_{BE}$

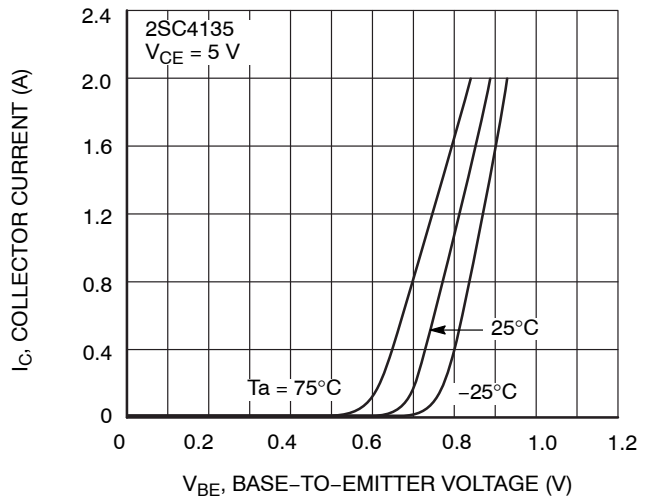

Figure 7.  $I_C - V_{BE}$

# 2SA1593 / 2SC4135

## TYPICAL CHARACTERISTICS (CONTINUED)

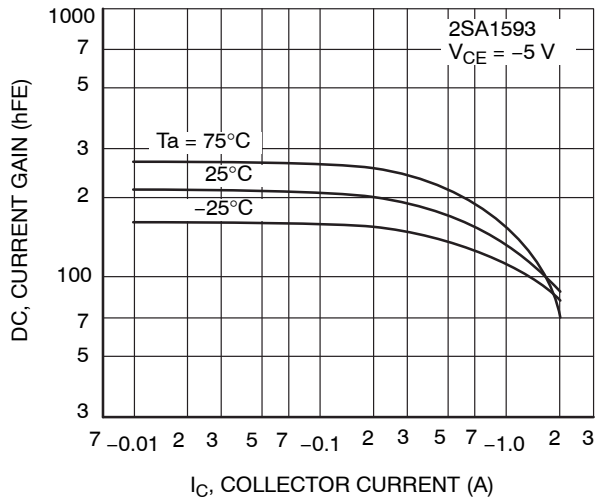

Figure 8.  $h_{FE} - I_C$

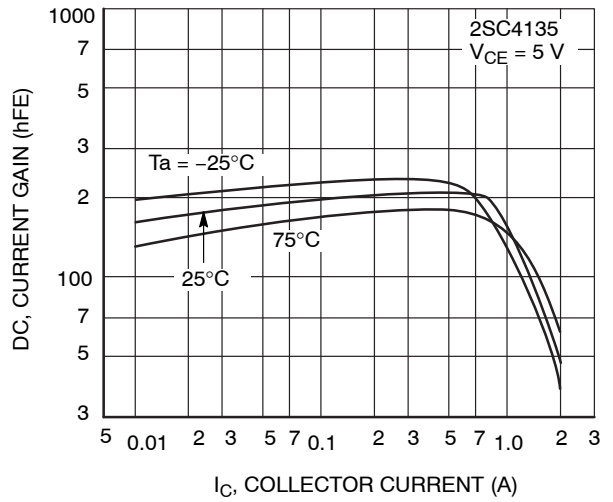

Figure 9.  $h_{FE} - I_C$

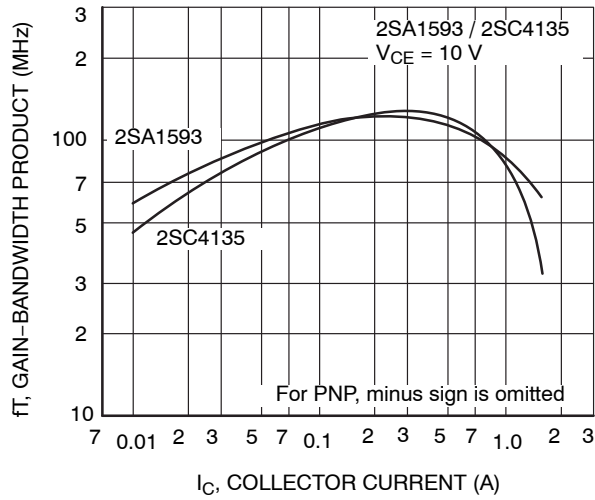

Figure 10.  $f_T - I_C$

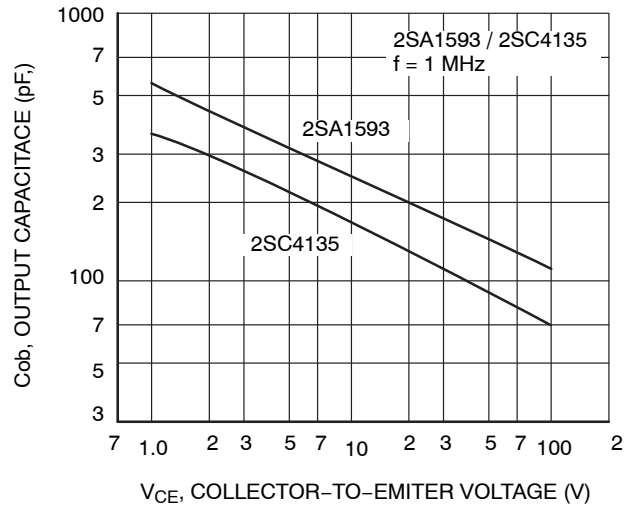

Figure 11.  $C_{ob} - V_{CE}$

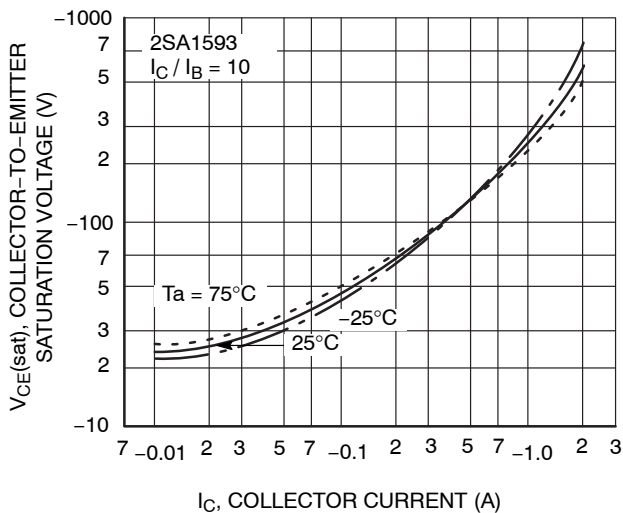

Figure 12.  $V_{CE(sat)} - I_C$

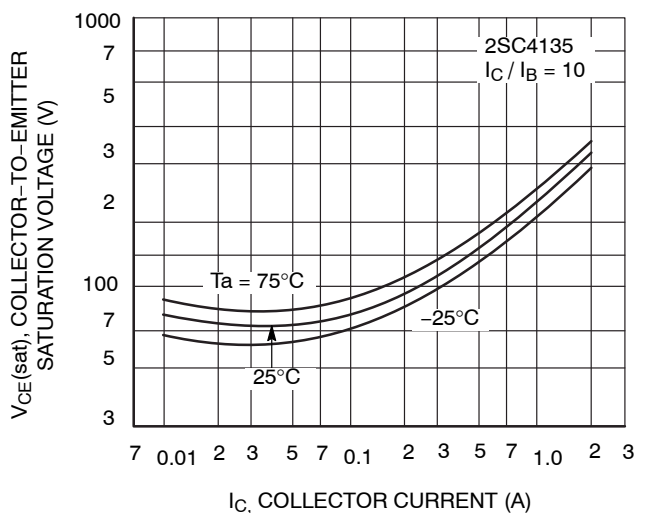

Figure 13.  $V_{CE(sat)} - I_C$

# 2SA1593 / 2SC4135

## TYPICAL CHARACTERISTICS (CONTINUED)

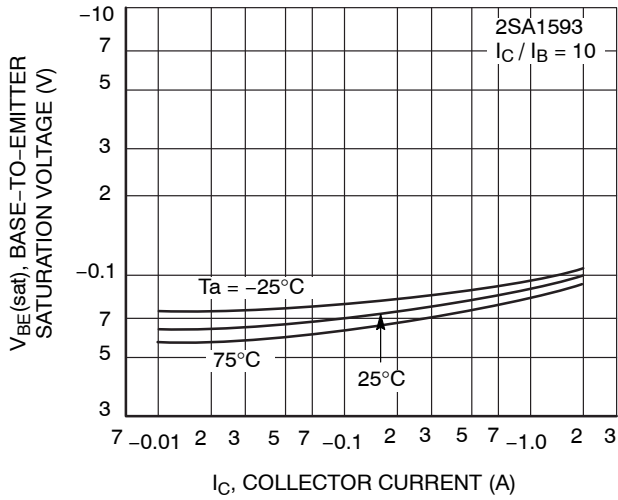

Figure 14.  $V_{BE(sat)} - I_C$

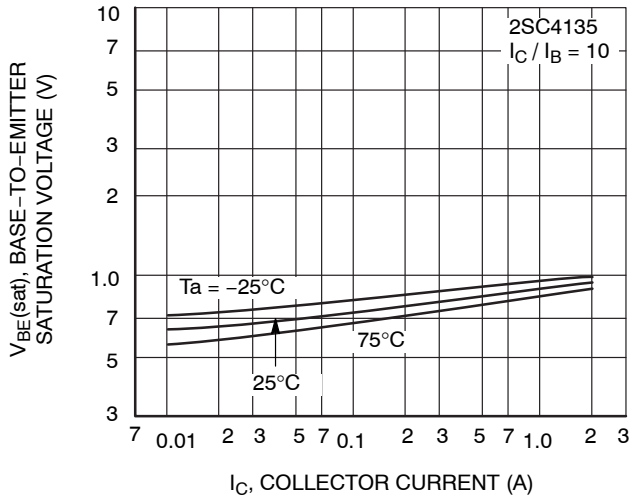

Figure 15.  $V_{BE(sat)} - I_C$

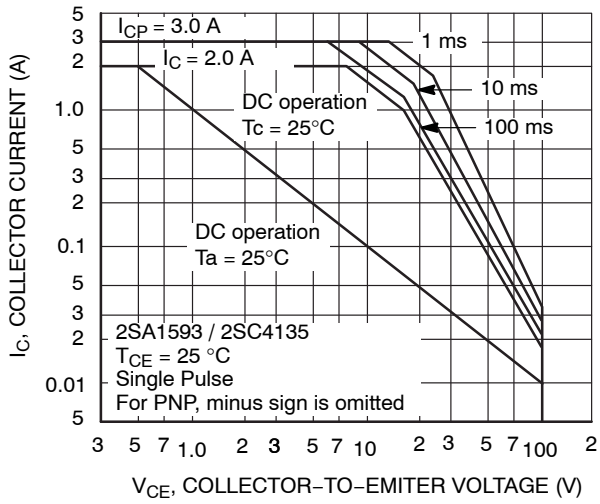

Figure 16. ASO

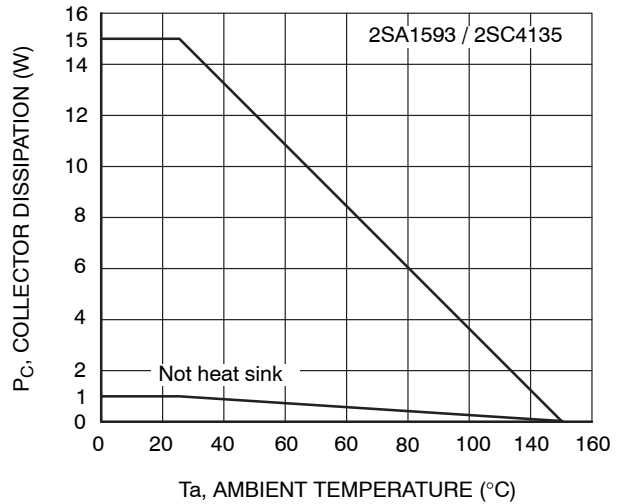
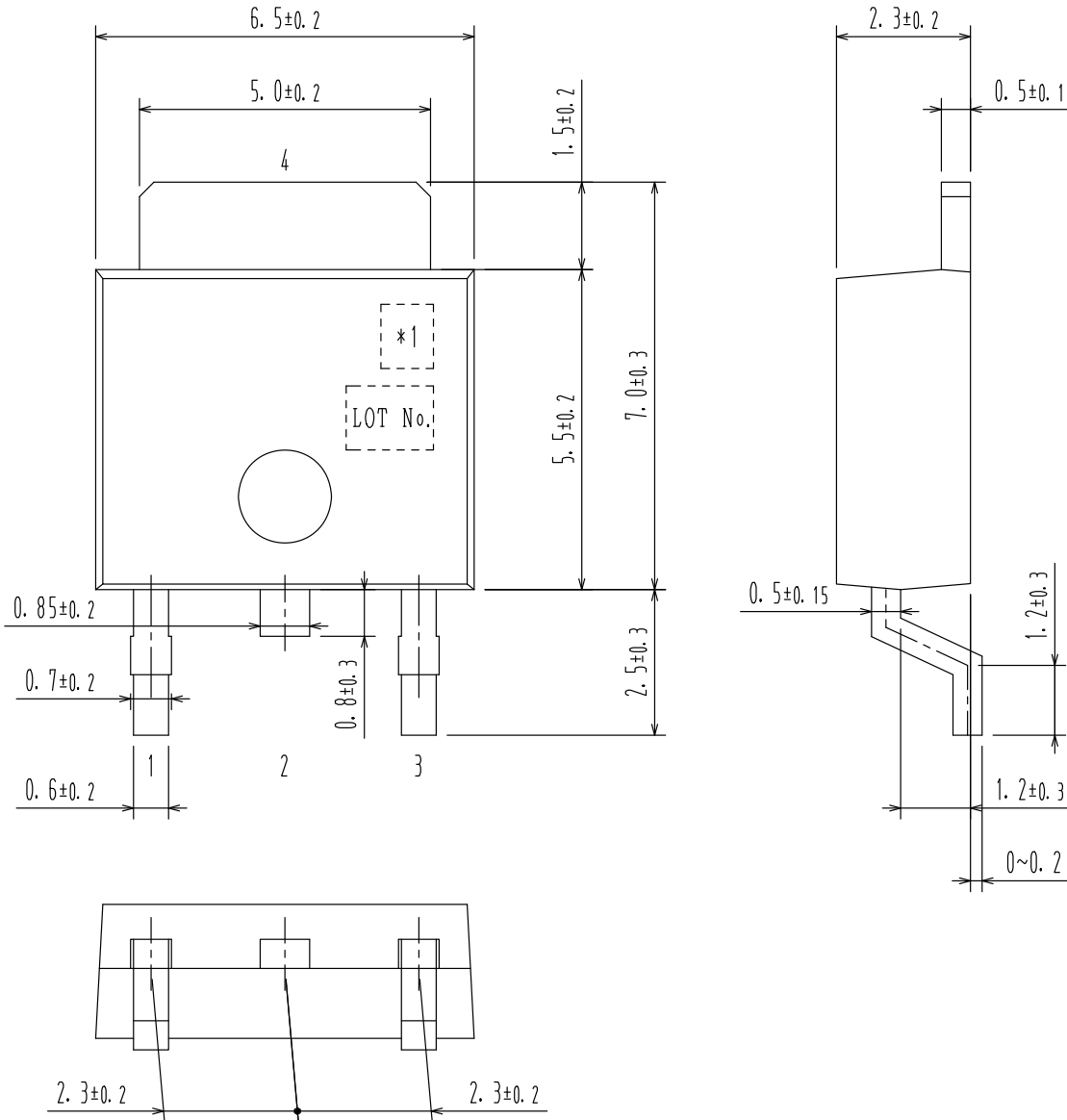

Figure 17.  $P_C - T_a$

**MECHANICAL CASE OUTLINE**  
**PACKAGE DIMENSIONS**

**DPAK / TP-FA**  
**CASE 369AH**  
**ISSUE O**

DATE 30 JAN 2012



Pin 2 is idle pin with electrical designation only carried.

- 1:
- 2:
- 3:
- \*1: Lot indication 4:

<b>DOCUMENT NUMBER:</b>	<b>98AON66236E</b>	Electronic versions are uncontrolled except when accessed directly from the Document Repository. Printed versions are uncontrolled except when stamped "CONTROLLED COPY" in red.
<b>DESCRIPTION:</b>	<b>DPAK / TP-FA</b>	<b>PAGE 1 OF 1</b>

ON Semiconductor and **ON** are trademarks of Semiconductor Components Industries, LLC dba ON Semiconductor or its subsidiaries in the United States and/or other countries. ON Semiconductor reserves the right to make changes without further notice to any products herein. ON Semiconductor makes no warranty, representation or guarantee regarding the suitability of its products for any particular purpose, nor does ON Semiconductor assume any liability arising out of the application or use of any product or circuit, and specifically disclaims any and all liability, including without limitation special, consequential or incidental damages. ON Semiconductor does not convey any license under its patent rights nor the rights of others.

**onsemi**, **Onsemi**, and other names, marks, and brands are registered and/or common law trademarks of Semiconductor Components Industries, LLC dba "**onsemi**" or its affiliates and/or subsidiaries in the United States and/or other countries. **onsemi** owns the rights to a number of patents, trademarks, copyrights, trade secrets, and other intellectual property. A listing of **onsemi**'s product/patent coverage may be accessed at [www.onsemi.com/site/pdf/Patent-Marking.pdf](http://www.onsemi.com/site/pdf/Patent-Marking.pdf). **onsemi** reserves the right to make changes at any time to any products or information herein, without notice. The information herein is provided "as-is" and **onsemi** makes no warranty, representation or guarantee regarding the accuracy of the information, product features, availability, functionality, or suitability of its products for any particular purpose, nor does **onsemi** assume any liability arising out of the application or use of any product or circuit, and specifically disclaims any and all liability, including without limitation special, consequential or incidental damages. Buyer is responsible for its products and applications using **onsemi** products, including compliance with all laws, regulations and safety requirements or standards, regardless of any support or applications information provided by **onsemi**. "Typical" parameters which may be provided in **onsemi** data sheets and/or specifications can and do vary in different applications and actual performance may vary over time. All operating parameters, including "Typicals" must be validated for each customer application by customer's technical experts. **onsemi** does not convey any license under any of its intellectual property rights nor the rights of others. **onsemi** products are not designed, intended, or authorized for use as a critical component in life support systems or any FDA Class 3 medical devices or medical devices with a same or similar classification in a foreign jurisdiction or any devices intended for implantation in the human body. Should Buyer purchase or use **onsemi** products for any such unintended or unauthorized application, Buyer shall indemnify and hold **onsemi** and its officers, employees, subsidiaries, affiliates, and distributors harmless against all claims, costs, damages, and expenses, and reasonable attorney fees arising out of, directly or indirectly, any claim of personal injury or death associated with such unintended or unauthorized use, even if such claim alleges that **onsemi** was negligent regarding the design or manufacture of the part. **onsemi** is an Equal Opportunity/Affirmative Action Employer. This literature is subject to all applicable copyright laws and is not for resale in any manner.

## PUBLICATION ORDERING INFORMATION

### LITERATURE FULFILLMENT:

Email Requests to: [orderlit@onsemi.com](mailto:orderlit@onsemi.com)

**onsemi Website:** [www.onsemi.com](http://www.onsemi.com)

### TECHNICAL SUPPORT

**North American Technical Support:**  
Voice Mail: 1 800-282-9855 Toll Free USA/Canada  
Phone: 011 421 33 790 2910

**Europe, Middle East and Africa Technical Support:**

Phone: 00421 33 790 2910

For additional information, please contact your local Sales Representative